

A=2800W white
 B=2700W Blu
 C=2100W red

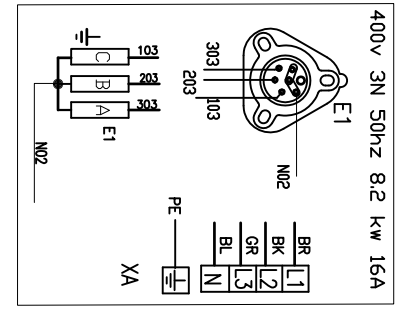
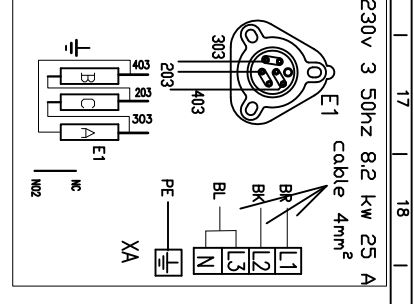
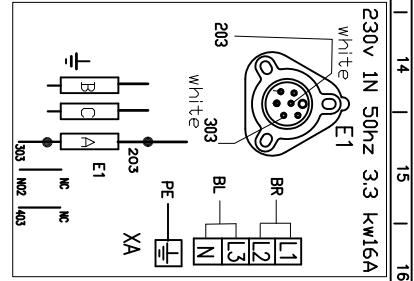
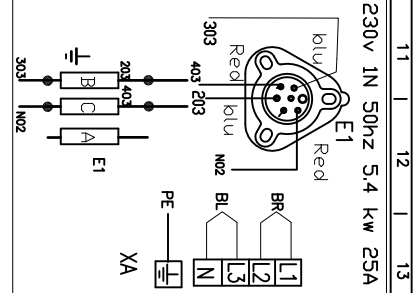

OPTIONAL

A= DRAIN PUMP
 B=REGENERATION
 C=DETERGENT
 D=RINSE PUMP
 E=RINSE AID PUMP

SCHEDA 88701106.0.A

P10	P26	P20	P1	P21	P22	P23	P24	P25	P11
P7	P13	P16	P14	P15	P17	P18	P12		

DESCRIZIONE		SOSTITUISCERE		DATA		Code Machine		Code	
Modifica collegamento desasteri		---		05/12/07		-----		81722	
Modifica collegamento neutro res boiler						Re-examined 07/02/12 Inspected by date		WIRING DIAGRAM LA 50 ELETTROMECCANICA Dishwashers Total BLOC 3 N° BLOC 1 Next BLOC -2	
						Validated by		n°/file 81722	
								mod	

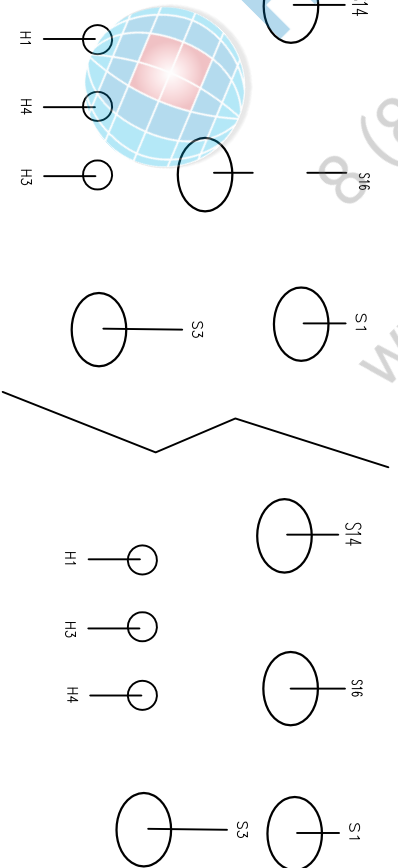
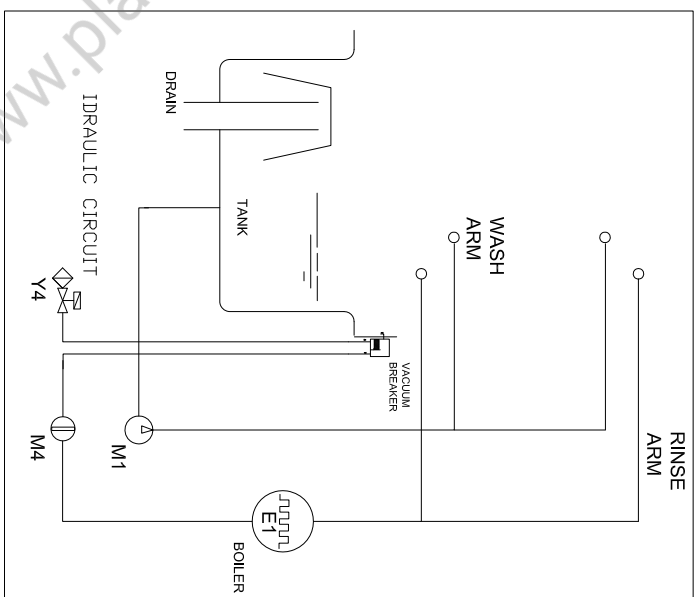
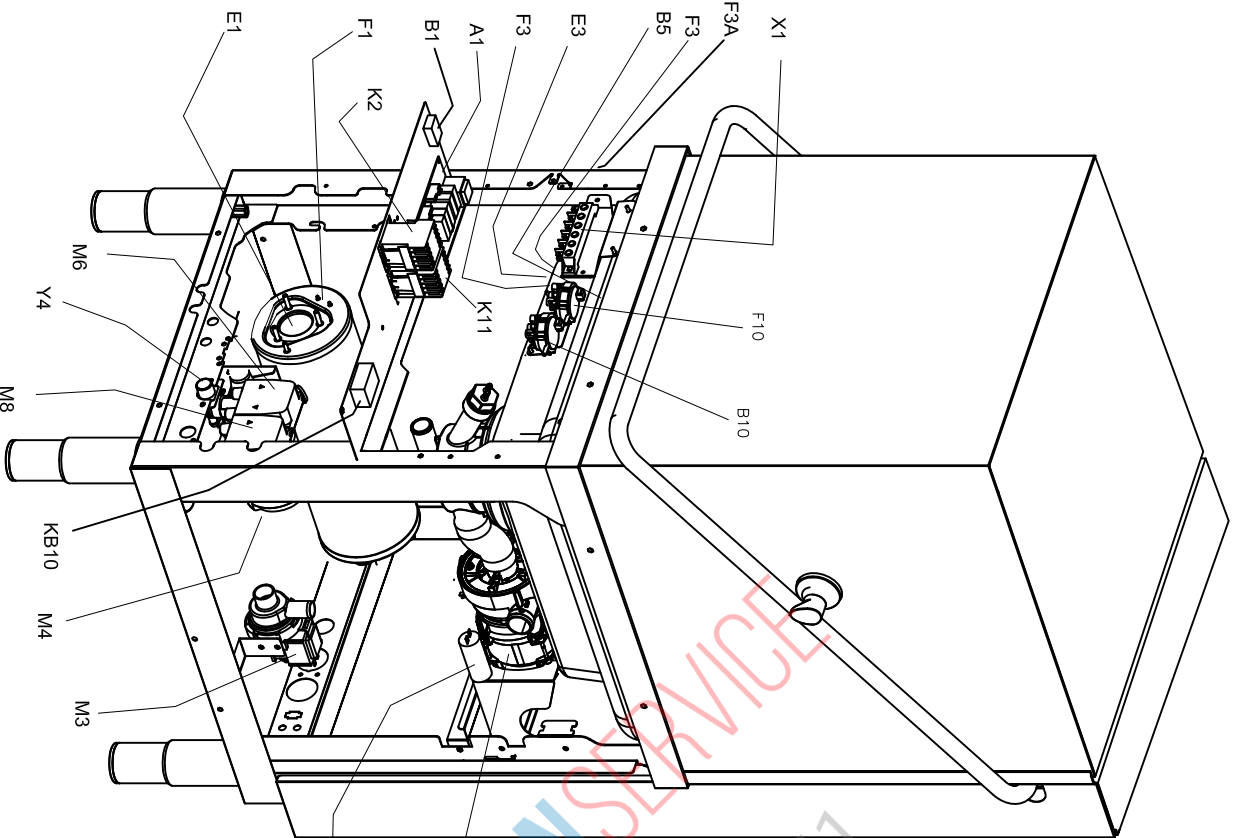

DESCRIZIONE

SUSSTITUISCE

DATA

re-examined by

denominazione

Codice

inspected by

date

WIRING DIAGRAM

81722

validated by

date

Dishwashers

n°/file

total Blatt

3

n° Blatt

2

next Blatt

-3-

81722

mod

PLATON SERVICE
 (800) 500-34-47
 www.platonservice.com

01	02	03	04	05	06	07	08	09	10	11	12	13	14	15	16	17	18
S14	PULSANTE DI LINEA MAIN SWITCH				INTERRUPTEUR DE LIGNE NETZSCHALTER												
B6	MICROINTERRUTTORE MAGNETICO MAGNETIC SAFETY MICROSWITCH				MICROINTERRUPTEUR MAGNETIQUE MAGNETISCHER SICHERHEITSSCHALTER												
S1	INTERRUTTORE DI CICLO CYCLE SWITCH				INTERRUPTEUR DE DEMARRAGE WASCHVORGANGSSCHALTER												
S16	SELETORE CICLO CYCLE COMMULATOR				SELECTEUR CYCLE WAESLSCHALTER FUER WASCHVORGANGSAUFAEHR												
F1	TERMOSTATO SICUREZZA BOILER SAFETY BOOSTER HEATER THERMOSTAT				THERMOSTAT DE SECURITE DU BOILER SICHERHEITSSICHERHEITSSCHALTER												
F3	TERMOSTATO SICUREZZA VASCA SAFETY TANK HEATER THERMOSTAT				THERMOSTAT DE SECURITE CUVE SICHERHEITSSICHERHEITSSCHALTER												
E3	RESISTENZA VASCA LAVAGGIO WASH TANK HEATING ELEMENT				RESISTANCE CUVE DE LAVAGE WASHTANKHEIZUNG												
E1	RESISTENZA BOILER BOOSTER HEATER HEATING ELEMENT				RESISTANCE BOILER BOILERHEIZUNG												
S3	START ELETTROPOMPA DI SCARICO START DRAIN PUMP																
M3	ELETTROPOMPA DI SCARICO DRAIN PUMP																
M4	ELETTROPOMPA AUMENTO PRESSIONE RINSE BOOSTER PUMP				ELECTROPOMPE AUGMENT PRESSION DRUCKSTUEIGENPUMPE												
M16	ELETTRODOSATORE DETERGIVO EL. DETERGENT INJECTOR				DOSEUR EL. DETERGENT SPUEL MITTELDOSEGERAET												
M1	ELETTROPOMPA LAVAGGIO WASH ELECTRIC PUMP				ELECTROPOMPE LAVAGE ELEKTRISCHE UMAELZPUMPE												
K11	TELURITTORE SICUREZZA RESISTENZA BOILER SAFETY BOOSTER HEATER CONTACTOR				CONTACTEUR RESISTANCE BOILER LUFTSCHLUETZ F. BOILERHEIZUNG												
000	REL. LAVAGGIO WASH RELAY																
K2	TELURITTORE RESISTENZA BOILER BOOSTER HEATER CONTACTOR				CONTACTEUR RESISTANCE BOILER LUFTSCHLUETZ F. BOILERHEIZUNG												
Y5	ELETTROVALVOLA RIGENERAZIONE REGENERATION SOLENOID VALVE																
W/6	ELETTROVALVOLA RISCIACCO RINSE SOLENOID VALVE				ELECTROVANNE DE RINCOAGE MAGNETVENT FUER NACHSPUELUUNG												
F	FUSIBLES FUSIBLES																
B3	TERMOSTATO RESISTENZA VASCA TANK HEATER THERMOSTAT				THERMOSTAT RESISTANCE DE CUVE THANKHEIZUNG/THERMOSTAT												
F1	TERMOSTATO SICUREZZA BOILER SAFETY BOOSTER HEATER THERMOSTAT				THERMOSTAT DE SECURITE DU BOILER SICHERHEITSSICHERHEITSSCHALTER												
B1	TERMOSTATO RESISTENZA BOILER BOOSTER HEATER THERMOSTAT				THERMOSTAT RESISTANCE BOILER BOILERHEIZUNG												
C1	CONDENSATORE CAPACITOR																
F10	PRESSOSTATO SICUREZZA LIVELLO VASCA SAFETY TANK PRESSURE SWITCH																
B10	PRESSOSTATO LIVELLO VASCA TANK PRESSURE SWITCH				PRESSOSTAT NIVEAU AIRCAP TANKDRUCKSCHALTER-NIVEAUREGLER												
A1	SCHEDE CONTROLLO ELECTRONIC CONTROL UNIT				FICHE DE CONTROLEELECTRONIQUE ELEKTRONISCHE BEDENNINGSKARTE												
SMB:	DESCRIZIONE DESCRIPTION				DESCRIPTION BESCHREIBUNG												

DESCRIZIONE

SUSSTITUTE

DATA

Code Machine	C600	denomination	Code	81722
Pre-examined	date	07/02/12	WIRING DIAGRAM	
Inspected by	date		n°file	81722
Validated by	date		mod	--
		Dismantlers	Wiring Diagram	
		Total Blat	1 st Blat	Next Blat
			3	-2